

SCREW AIR COMPRESSOR
TYPE: MAM-890 (B) (3R) -II

USER
MANUAL

Joy Machinery (Shanghai) Co., Ltd

Address: Building 8, No.1098, Chuansha Road, Pudong New District,
Shanghai City, China.

Telephone: (021) 60382839

Fax: (021) 60382839

Web site: www.shairbuild.com

E-mail: info@shairbuild.com

VOTE OF THANKS

Thank you for your trustworthy and select of our air compressor controller !

Joy Machinery (Shanghai) Co., Ltd specializes in the manufacture and R&D of air compressor controller. We devote to win customer trust through our high quality products and service.

We try our best to ensure the completeness and correctness of the manual, but JOY MACHINERY Company shall reserve the rights for continuous research and improvement on its products and assume no obligation for the modification and improvement on the previously delivered products. The design of products is subject to the change without notice.

Please feel free to contact our after-sale service center if you encounter any problem with our product.

You are always welcome to make suggestions and advices!

Notice



Please read all the operation manual before operating the set and keep this manual for further reference.



Installation of MAM—8** compressor controller can be performed only by professional technicians.



Installation position shall be considered carefully in order to ensure good ventilation and reduce electromagnetic interference.



Wiring shall be performed respectively according to regulations for heavy and weak current to reduce electromagnetic interference.



RC snubber must be connected to the two terminals of coil (such as AC contactor ,valve, etc),which are controlled by relay output.



Port connection shall be inspected carefully before power on.



Correct ground connection (the third ground)can help increase product capacity of resisting signal interference.



Set rated current of motor: the max current of motor/1.2.

Features:

- Chinese / English display.
- Remote control/Local control.
- Block mode/Independent mode.
- On-off control of motor.
- Prevention for air compressor reversion.
- Temperature measurement, control and protection.
- Voltage measurement and protection.
- RS485 communication function, supporting MODBUS RTU protocol.
- Protection for open phase, overload current, unbalance current, high voltage, low voltage.
- High integration, high reliability, high cost performance.

Contents

1、 Basic Operation	5
1、 Button Explanation	5
2、 Indicator instructions	6
3、 Status Display and Operation	6
4、 Operating parameters and Menu	7
5、 User Parameter View and Modification:	7
6、 Customer Parameter and Functions	8
7、 Factory Parameter View and Modification	10
8、 Factory Parameter Sheet and Function	10
9、 Calibration Parameter	11
10、 Operating Authorization and Password	12
2、 Controller Function and Technical Parameter	13
3、 Model and specification	14
1、 Instruction of type	14
2、 Specification table for power of suited motor	14
4、 Installation	15
1、 Mechanical Installation	15
2、 Controller Installation	15
2、 Electrical Wiring Installation	16
5、 Alarm Function	17
1、 Air Filter Alarm	17
2、 Oil Filter Alarm	17
3、 O/A separator Alarm	17
4、 Lubricating Oil Alarm	17
5、 Grease Alarm	17
6、 Belt Alarm	17
7、 High Discharge Air Temperature Alarm	17
6、 Controller protection	18
1、 Motor protection	18
2、 Protection of High Discharge Air Temperature	18
3、 Protection of Air Compressor Non-reversing	18
4、 Protection of High Pressure	18
5、 Protection of Sensor Failure	18
7、 Troubleshooting	18
1、 This Fault Review	18
2、 Common Failures and Causes	19
8、 Block mode control and net work	20
1、 Block mode control	20
2、 Net Work	21
9、 Schematic Diagram	22

1、 Basic Operation

1、 Button Explanation

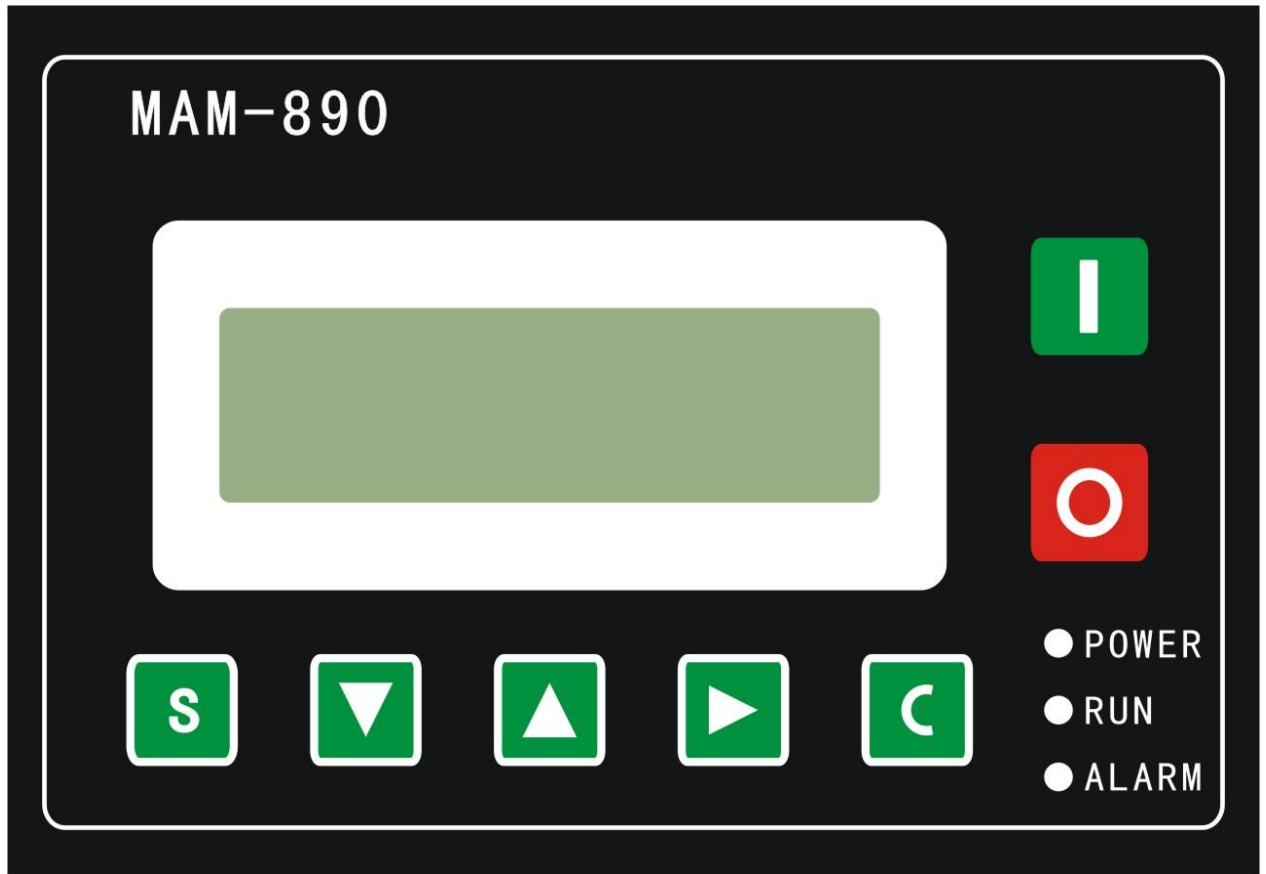





Figure 1.1.1

-  —Start Button:
 - 1, When compressor is at stop status, press this button to start the compressor.
 - 2, When compressor is set as master (No.1) in block mode, press this button to start the compressor and activate block mode function at the same time.
-  —Stop Button:
 - 1, When the compressor is at running status, press this button to stop the compressor;
 - 2, When compressor is set as master (No.1) in block mode, press this button to stop compressor and block mode function as well;
 - 3, When compressor is at stop status, long press this button to display software edition.
-  —Set Button /Loading / unloading Button:
 - 1, When the compressor is at running status, press this button to load, unload;
 - 2, When the compressor is at setting mode, press this button after modification to

confirm and save the modified data.



——Move down button / Decreasing button:

- 1, When viewing the menu, press this button to move downward the cursor;
- 2, When modifying data, press this button to decrease the data at current position.



——Move up button/Increasing button:

- 1, When viewing the menu, press this button to move upward the cursor;
- 2, When modifying data, press this button to increase the data at current position.



——Shift button /Enter button:

- 1, When modifying data, press this button to move to the next data bit;
- 2, When select menu, press this button to switch to submenu. If no submenu available, the controller will shift to data setting mode.



——Return button / Reset button:

- 1, When modifying data, press this button to exist data setting mode;
- 2, When viewing the menu, press this button to return to previous menu;
- 3, When the controller is at failure stop status, long press this button to reset.

2、Indicator instructions

Power Indicator: Indicator on when controller is energized.

Run indicator: Indicator is on when motor is running.

Alarm indicator: Indicator is blinking when alarming; indicator on when fail to stop; indicator off when error is cleared

3、Status Display and Operation

The display screen will show as below after power on:

SCREW
COMPRESSOR

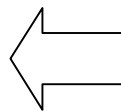

After power on, show this menu

After 5 seconds, the main page will show up as:

PRES: 0.60MPa
SYS STOP C01

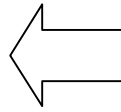

Main menu

Press “”, the main menu will show up as:

TEMP: 80°C
SYS STOP C01

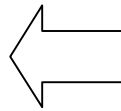

Main menu

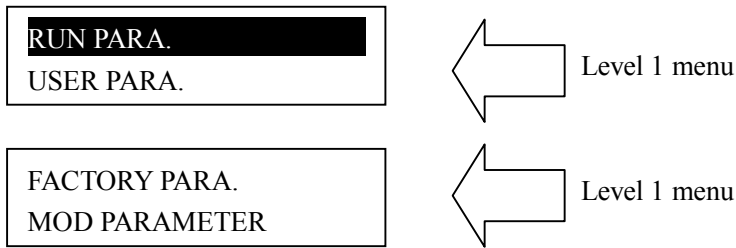

Press “” to enter into Selection Menu:



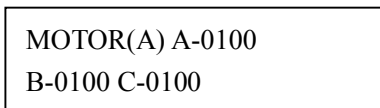

4、 Operating parameters and Menu

Press “” to move the cursor to “RUN PARAMETER”, then press “” to switch to the secondary menu:



Press “” to check the specific parameter. Such as viewing " FAN CUR ", "RUN TIME", "LOAD TIME" and so on. Press the “” to return to the previous menu or the main menu. If no operation at the current menu for 60 Seconds, controller will automatically return to the main menu.





5、 User Parameter View and Modification:

In first menu, press the “” and “” to move the cursor to the "USER PARA." item, press the “” to switch to the following menu:







In this menu, press “” to switch to the following menu which requires a user password input.

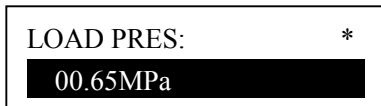

In this menu, the first data bit of password started blinking, press “” or “” to modify the the first bit of password, Press the “”, move the cursor to the next data bit, modify the second data of password. In accordance with the above, modify the third and fourth data of password in sequence. Press“” to confirm the input data and the menu will switch to the following menu after verification:



The upper right corner with "*" indicates the system verification of the password

In the menu above, press “”, the first data of loading pressure starts to blink, user can press “” or “” to modify the present data in accordance with the above method .Press “” to move to next data bit and modify to the target data in sequence. When finished, press “” to confirm and save the data. The controller prompt sends out a short voice to tip the completion of parameter set.



6、Customer Parameter and Functions

Parameters	Preset Value	Functions
LOAD P.	00.60MPa	1, In AUTO LOADING, compressor will load if pressure is below this set data 2, In STANDBY mode, compressor will start if the pressure is below this set data
UNLOAD P.	00.80Mpa	1, Compressor will unload automatically if air pressure is above this set data 2, This data should be set above LOAD P ,also should be set below ULD LIM P
FAN START T	0080°C	Fan starts when discharge temperature is above the data set.
FAN STOP T	0070°C	Fan stops when discharge temperature is below the data set.
MOTOR DELAY	0008S	Set the master start time, record time when master is activated, controller will not start overload protection during this time to avoid stopping the master by impulse starting current
STAR DELAY	0006S	Time from star start to delta start.
LOAD DELAY	0002S	Unloading in this set time after enter delta running
UNLOAD DELAY	0600S	When unloading continuously, compressor will automatically stop and enter to standby status if over this set time

STOP DELAY	0010S	For NORMAL STOP operation, compressor will stop after it continuously unloading over this set time
START DELAY	0100S	Machine can be restarted only over this set time at any case(after NORMAL STOP, STANDBY or FAILURE STOP)
ON/OFF MODE	LOCAL/REMOTE	1,When set as LOCAL ,only the button on the controller can turn on and turn off the machine. 2,When set as REMOTE mode, both the button on the controller and the remote control button can turn on and off the machine;
LOAD MODE	AUTO/MANU	1,When set as the MANU: only when the pressure is above “unloading pressure”, compressor will unload automatically .For any other case, the Loading/Unloading function can only be executed by pressing “loading /unloading ” key. 2,When set as AUTO ,the loading/ unloading function can be executed by the fluctuation of air pressure automatically
COM MODE	PROHIBIT /COMP./BLOCK	1,When set as PROHIBIT, the communication function is invalid. 2,When set as COMP. ,compressor function as a slave and is able to communicate with computer or DCS 3,When set as BLOCK, compressor can net control
COM ADDRESS	0001	Set the communication ADD in block mode or when communicate with monitoring center. This ADD is unique for every controller in net
BLOCK MODE	MASTER/SLAVE	1,When service as master in BLOCK. Master controls slave, the COM ADDRESS should be No.1 2,When service as slave in BLOCK, slave is controlled by master
TURN TIME	0099 Hours	When master pressure is between BLOCK LOAD P and BLOCK UNLOAD P, master determine slave work alternatively over this set time .
BLK NUMER	0000	Number of air compressors in block net
BLK MIN	00.65MPa	In BLOCK, one compressor will start or load when pressure is below this set data
BLK MAX	00.75MPa	In BLOCK mode, one compressor will stop or unload when pressure is above this set data
BLK DELAY	0050S	In BLOCK mode, when master sends two commands continuously, second command signal delays for this set data,
OIL FILTER	0000H	Record total running time of oil filter, if changing new oil filter, the data should be reset by manual operation.
O/A SEPARATOR	0000H	Record total running time of O/A separator. If changing new O/A separator, the data should be reset by manual operation
AIR FILTER	0000H	Record total running time of air filter .If changing new air filter, the data should be reset by manual operation
LUBE	0000H	Record total running time of lube. If changing lubricate ,the data should be reset by manual operation
GREASE	0000H	Record total running time of grease. If changing new grease, the data should be reset by manual operation
BELT	0000H	Record total running time of belt. If changing new belt, the data should be reset by manual operation

OIL FILTER	9999H	1,Alarm prompts when total running time of oil filter is above the set data. 2,Set this data to “0” to clear oil filter running time
O/A SEPARATOR	9999H	1,Alarm prompts when total running time of O/A separator is above the set data. 2,Set this data to “0” to clear O/A separator running time
AIR FILTER	9999H	1,Alarm prompts when total running time of air filter is above the set data. 2,Set this data to “0” to clear air filter running time
LUB	9999H	1,Alarm prompts when total running time of lubricate is above the set data. 2, Set this data to “0” to clear lubricate running time.
GREASE	9999H	1,Alarm prompts when total running time of grease is above the set data. 2,Set this data to “0” to clear grease running time
BELT	9999H	1,Alarm prompts when total running time of belt is above the set data. 2,Set this data to “0” to clear belt running time .
LANGUAGE SEL	ENGLISH/CHINESE	1,Set to “EN”, Display in English 2,Set to “CH”, Display in Chinese
USER PASSWORD	****	User could modify the user password by old user password or factory password
START MODE	STAR-DELTA / DIRECT	Set as star-delta, compressor starts through the process from star to delta; Set as direct start, compressor starts directly and no star-delta process.(see the two schematic diagrams for reference)

7、Factory Parameter View and Modification

FACTORY PARAMETER store relatively parameter set by factory. To check FACTORY PARAMETER, you have to verify password first. In the first menu, press “” and “” to FACTORY PARAMETER, press “”to switch to the menu below.

PASSWORD : 0***

Input the correct password to switch to the FACTORY PARAMETER menu as below:

MOTOR CURR: *

100.0A

For more factory parameter, please check factory parameter sheet. When modify factory parameter, please refer to customer parameter modification method, supper password is required to set TOTAL RUN TIME,PHASE PROT,POWER FREQ and MAX RUN TIME.

8、Factory Parameter Sheet and Function

PARAMETER	Initial Value	Functions
MOTOR CURR	MAXIMUM	When the current of motor is more than 1.2 times of

	OVERLOAD VAULE OF THE MOTOR /1.2	the set data, the unit will stop for overload feature. (see table2.1.1)
ALARM T.	105℃	When discharge air temperature reaches this set data, compressor will alarm
STOP T.	110℃	When the discharge air temperature reaches this set data, compressor will alarm and stop
STOP P.	1.00MPa	When pressure reaches this set data ,compressor will alarm and stop
MAX U.L.	0.80MPa	This data is the maximum of UNLOADING P. The UNLOADING P in the customer parameter must be set no higher than this data.
RUN TIME	000100Hours	Modify the TOTAL RUN TIME
LOAD TIME	000095Hours	Modify the TOTAL LOAD TIME
CLR FAULT	****	Input the password 8888 and press “set “button to clear all the history failure record.
CUR UN.BAL.	0006	MAX-MIN \geq SET*MIN/10 ,respond time is 5s If the set data \geq 15, the unbalance protection will be invalid.
OPEN PAHSE	002.0s	If OPEN PHASE protection \geq 20 seconds, OPEN PHASE protection is invalid
PROD DATE	****_**_**	Production date
PROD NO	*****	Product serial No.
PHASE PROT..	ON/OFF	ON: turn on phase sequence protection OFF: turn off phase sequence protection
POWER FREQ	50HZ/60HZ	Set the operation power frequency
TIME LIM	0000H	1,When the compressor is in a stop status and the TOTAL RUN TIME exceeds this TIME LIM set, the controller will stop the compressor and display USER MISTAKE; 2,If this data is set to ‘0000’, TIME LIMIT function is invalid.
ALM STOP	0010H	Controller detects oil filter, O/A separator, air filter, lubricate oil ,grease and belt running with alarming over this ALARM STOP set, compressor will stop and report ”ALARM LONG STOP ”
COM SET PARA	ON/OFF	1,When set as ON, User can use DCS to set data through MODBUS protocol; 2,When set as OFF, User cannot use DCS to set data through MODBUS protocol 3, User can use DCS to set data only when compressor is at stop status
PARA1	****	User could modify the factory password by old factory password.
START MODE SEL	DIRECT START/STAR-DELTA	DIRECT START or STAR-DELTA
LED NUM	3LED	Set as 3LED

9、 Calibration Parameter

You can set relative data of controller in CALBR PARA. It is not allowed to view and modify without manufacturers authorization, so please verify the password before view and modification. The modification

of CALBR PARA is similar with CUSTOMER PARA. Main function is shown as below.

FACTORY PARA.
MOD PARAMETE

PARAMETER		Initial Value	Functions
M O T O R A	TARGET CUR	0000	1,When calibrate the current of motor A, revise standard current data, controller calibrate the current by figuring the current coefficient and save the data automatically 2,Standard current data will return to zero after calibration
	COEF	1.000	When calibrate the current, revise coefficient. Current data in display=sample data*coefficient
	CUR	***.*A	This data is qret
M O T O R B	TARGET CUR	0000	1,When calibrate the current of motor B, revise standard current data, controller calibrate the current by figuring the current coefficient and save the data automatically 2,Standard current data will return to zero after calibration
	COEF	1.000	When calibrate the current, revise coefficient. Current data in display=sample data*coefficient
	CUR	***.*A	this data is qret
M O T O R C	TARGET CUR	0000	1,When calibrate the current of motor C, revise standard current data, controller calibrate the current by figuring the current coefficient and save the data automatically 2,Standard current data will return to zero after calibration
	COEF	1.000	When calibrate the current, revise coefficient. Current data in display=sample data*coefficient
	CUR	***.*A	this data is qret

10、 Operating Authorization and Password

Controller provides multiple passwords and access management. According to different levels of passwords, controller provides different levels of operating authorization, details as following:

1. User operation password: fixed:_____

Permissions: allows to modify the LOADING P, UNLOADING P, FAN START T, FAN START T, ON/OFF MODE, LOAD MODE, COM MODE, COM ADD and BLOCKING MODE.
2. New user password: factory set:_____

Permissions: Allows to modify all CUSTOMER PRAMETER.

3. Mmanufacturer sales password: factory set: _____
Permissions: Allows users to modify all CUSTOMER PRAMETER, the NEW USER PIN, some MANUFACTURER PARAMETER, MANUFACTORY SALES PASSWORD.
4. Mmanufacturer operation Password: fixed: _____
Permissions: Allows users to modify all CUSTOMER PRAMETER, the NEW USER PIN, some MANUFACTURER PARAMETER, MANUFACTORY SALES PASSWORD.
5. Calibrate Password: fixed: _____
Permissions: Allows users to calibrate currents in CALBR PARAMETER.
6. Super Password: fixed: _____
Permissions: Allows users to modify TOTAL RUN TIME, PHASE SEQUENCE PROTECTION, OPWER FREQUENCY, TIME LIMIT after user enter factory parameter and verify supper password.

2、 Controller Function and Technical Parameter

- 1、 Digital input&output: 2 points of digital input ;3 points of digital relay output ;
- 2、 Analog input: 1 point of Pt100 temperature input ; 1 point of 4~20mA pressure signal input; one group of three phases current inputs(CT provided);
- 3、 Controller power supply: AC16-28V、 50/60HZ、 0.3A、 5VA (Recommend:10VA);
- 4、 Measurement
 - ①、 Discharge air temperature:-50~150℃; Accuracy: ±1℃.
 - ②、 Operation time: 0~999999 hours.
 - ③、 Current:0~999.9A.
 - ④、 Pressure: 0~1.60MPa. Accuracy: ±0.01Mpa.
- 5、 Protection of motor: this controller has five basic protection functions for main motor and fan's motor
 - ①、 Open phase protection: When any phase opens, the respond time equals to set time, when phase open time is set above 20s,open phase protection is invalid;
 - ②、 Unbalance protection: when $MAX-MIN \geq SET*MIN/10$, respond time is 5s;
 - ③、 Protection features of overload (time unit: second), please see following table (table 2.1.1), multiple $= I_{actual} / I_{set}$, motor operates with delay time according to overload multiples and operation time shown in following table (table 2.1.1) when motor working current is higher or equal to the set current from 1.2 times and 3.0 times .

I_{actual}/I_{set} Time parameters	≥ 1.2	≥ 1.3	≥ 1.5	≥ 1.6	≥ 2.0	≥ 3.0
Operation time (S)	60	48	24	8	5	1

Table 2.1.1 curve table of reverse time limit for protection of motor

- 6、 Temperature protection: when actual temperature measured is larger than temperature set; response time \leq

2s;

- 7、 Contact capacity of output relay: 250V,5A; Contact endurance 500000 times
- 8、 Current error is less than 1.0%.
- 9、 RS485 communication function
 - 1, Block mode control
 - 2, Communicate with-external devices as slave through MODBUS RTU, baud rate 9600BPS,1start bit,8 data bits,1 stop bit and even parity
- 10、 Remote control compressor: When set as remote control mode, user can remotely control the compressor.
- 11、 Remote or local start block mode.

3、 Model and specification

1、 Instruction of type

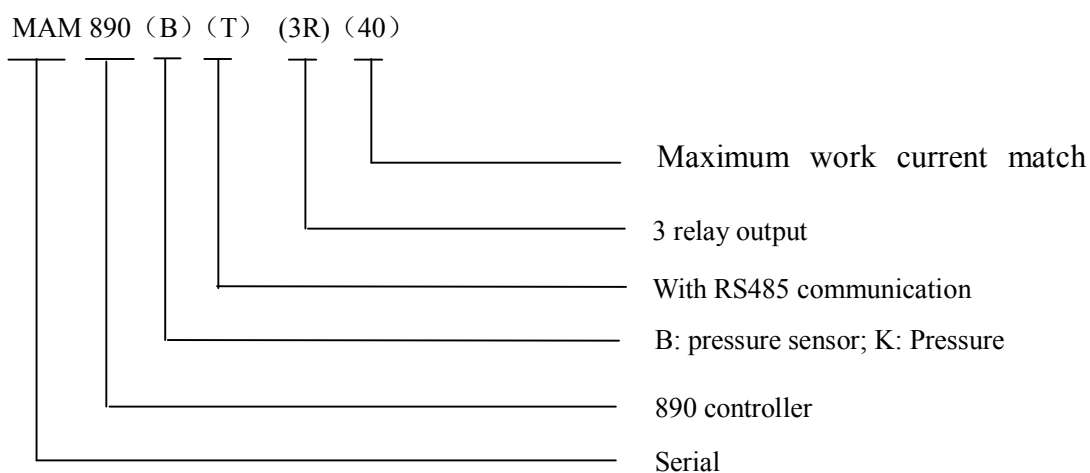

2、 Specification table for power of suited motor

Specification	Current range (A)	Corresponding main motor power (KW)	Remark
MAM890 (20)	8~20	Below 11	
MAM890 (40)	16~40	11-18.5	
MAM890 (100)	100	22-45	
MAM890 (200)	200	55-90	
MAM890 (400)	400	110	
MAM890 (600/5)	600/5	200-250	With CT

Table 3.2.1 Power Table

4、 Installation

1、 Mechanical Installation

The CT shall be installed at a place where the current of motor cable can be measured, thus controller can be set according to instructions on motor nameplate, the detailed dimensions is shown as below:

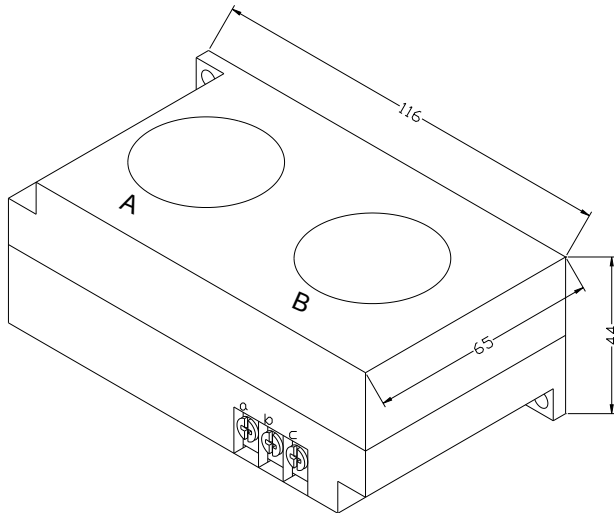

Figure 4.1.1. Structural dimensions of CT1 (φ36 through hole)

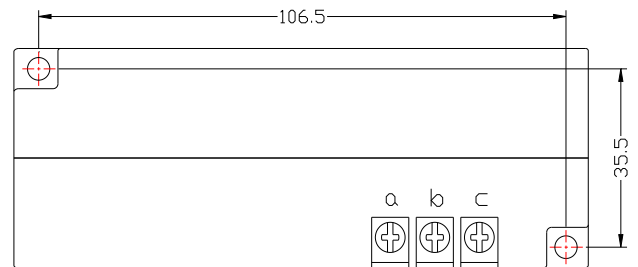

Figure 4.1.2. Install dimensions of CT1

2、 Controller Installation

A certain room should be left around controller for wiring. The specific dimension is shown as below:

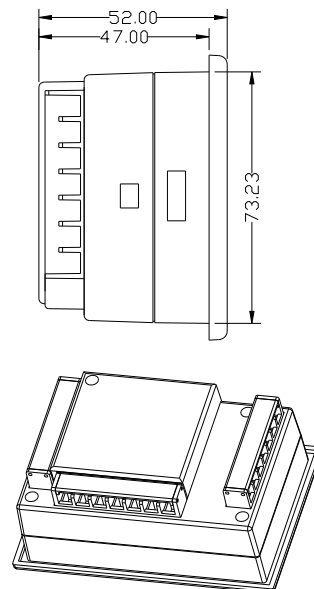
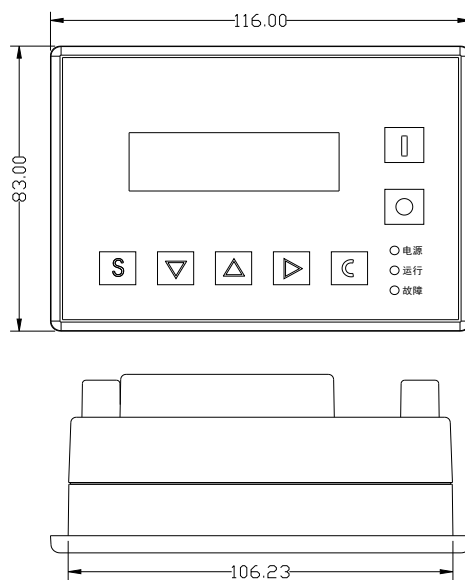

Figure 4.1.5 Controller structure dimensions

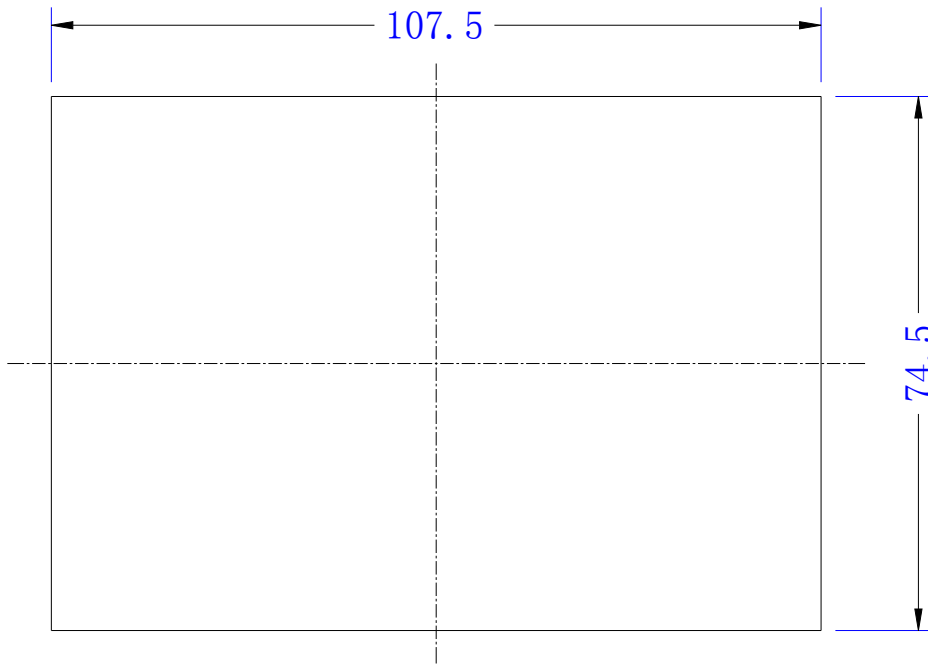

Figure 4.1.6 Hole size

2、Electrical Wiring Installation

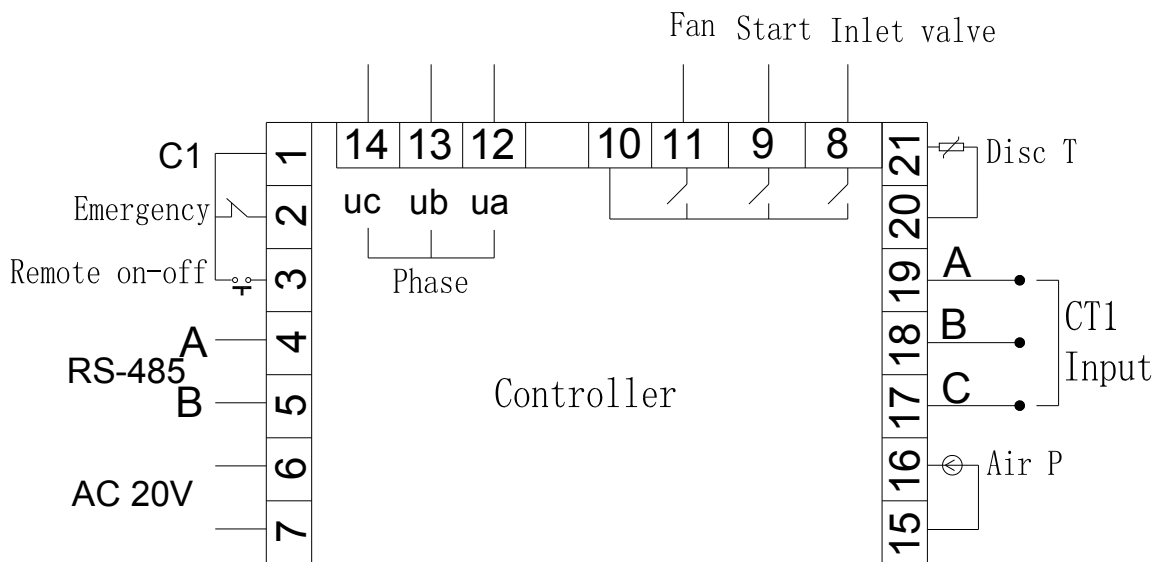

Figure 4.2.1 Terminal arrangement diagram

①、 **Cable connection of controller:**

<u>1</u>	Common terminal for digital input	<u>2</u>	Input terminal for emergency stop signal	<u>3</u>	Input terminal for remote control signal (on/off)
<u>4,5</u>	RS485 communication port	<u>6,7</u>	AC 20V power	<u>8</u>	Control inlet valve
<u>9</u>	Control start/stop valve	<u>10</u>	Digital output common terminal	<u>12,13,14</u>	Input terminal for phase test
<u>15,16</u>	Connect pressure sensor	<u>17,18,19</u>	Connect motor current transformer	<u>20, 21</u>	Connect temperature sensor

Note :Electromagnetism coil shall be connected nearest with RC snubber during wiring

5、 Alarm Function

1、 Air Filter Alarm

The monitor displays AIR LIFE END when the running time of the air filter exhausts.

2、 Oil Filter Alarm

Oil filter alarm

The text displays OIL LIFE END when running time of the oil filter exhausts.

3、 O/A separator Alarm

The text displays “O/A LIFE END” when running time of the O/A separator exhausts.

4、 Lubricating Oil Alarm

The text displays LUBE LIFE END when running time of the lubricating exhausts.

5、 Grease Alarm

The text displays GREASE LIFE END when running time of the grease exhausts.

6、 Belt Alarm

The text displays BELT LIFE END when running time of the belt exhausts.

7、 High Discharge Air Temperature Alarm

The text display HIGH TEMPERATURE when controller detects the discharge air temperature higher than ALARM T set data in MANUFACTORY PARA.

6、 Controller protection

1、 Motor protection

MAM-890 air compressor controller provides overload, open phase, current unbalance for motor

Electronic failure	Failure Display	Reason
Overload	Display “MASTER/FAN OVER LOAD”	Overload, bearing wear and other mechanical failure
Open phase	Display “MASTER OPEN PHASE”	Power supply, contactor and open phase of motor
Unbalance	Display “MASTER-UNBLANCE”	Poor contact of contactor, inside open-loop of motor

2、 Protection of High Discharge Air Temperature

When discharge air temperature is above the high limit of set temperature, the controller will send out the alarm to shut down the machine and This fault displays HIGHT T.

3、 Protection of Air Compressor Non-reversing

When compressor stops and three phases sequence is not in order, THIS FAULT displays PHASE REVERSAL, and the controller cannot start the motor. Change the position of any arbitrary two-phase power lines and check the rotation of motor.

4、 Protection of High Pressure

When the discharge air pressure is above the MAX LIM P, the controller will send out the alarm to shut down the machine and THIS FAULT displays HIGH P.

5、 Protection of Sensor Failure

When pressure sensor or temperature sensor is disconnected, the controller will send out the alarm to shut down the machine and THIS FAULT displays **SENSOR FAULT.

6、 Low Temperature Protection

When discharge air temperature is below LOW T PRO in manufacturing parameter, THIS FAULT displays P SENSOR FAULT two minutes after compressor turns on, the controller will send out the alarm to shut down the machine.

7、 Troubleshooting

1、 This Fault Review

Failure stop caused by the external parts of controllers may be removed by checking THIS FAULT or HISTORY FAULT , method is shown as below:

When a fault occurs, the controller in the main interface displays the current fault content. For example, When the pressure sensor failure, it displays the following interface:

<p>STOP: P SENSOR FAULT</p>

User can reset the error according to the following information

2、 Common Failures and Causes

Failure	Reason	Solution
High temperature of discharge air	Bad vent condition, Oil shortage etc.	Check the vent condition and lubricant amount etc.
Temperature Sensor Failure	Cable off or PT100 failure	Check the wiring and PT100
High Pressure	Pressure too high or the pressure sensor failure	Check the pressure and the pressure converter
Pressure Sensor Failure	Cable off, Sensor failure or the cable connect reversed	Check the wiring and pressure converter
Open Phase	Power open phase or the contactor terminal failure	Check the power and contactors
Overload	Voltage too low, tubes block, bearing wear off or other mechanical failure or wrong set data etc.	Check the set data, voltage, bearings, tubes and other mechanical system.
Unbalance	Power unbalance, contactor failure or the internal open loop of the motor	Check the power, contactor and the motor
Wrong Phase Sequence	Reversed phase sequence or open phase	Check the wiring
Overload during start	Master start time set to less than the star delta delay time	Reset the master start time to be longer than star delta delay + 2 seconds
Main Contactor shakes frequently	The emergency button loose, controller reset by interference	Check the wiring; if the coil of contactor connect with surge absorber or not

8、 Block mode control and net work

1、 Block mode control

① Block control explanation

MAM890 controller can block operate with MAM series compressor (with communication function).16 pcs compressors are allowed in the net at most. The cable connection for block mode control is as below....

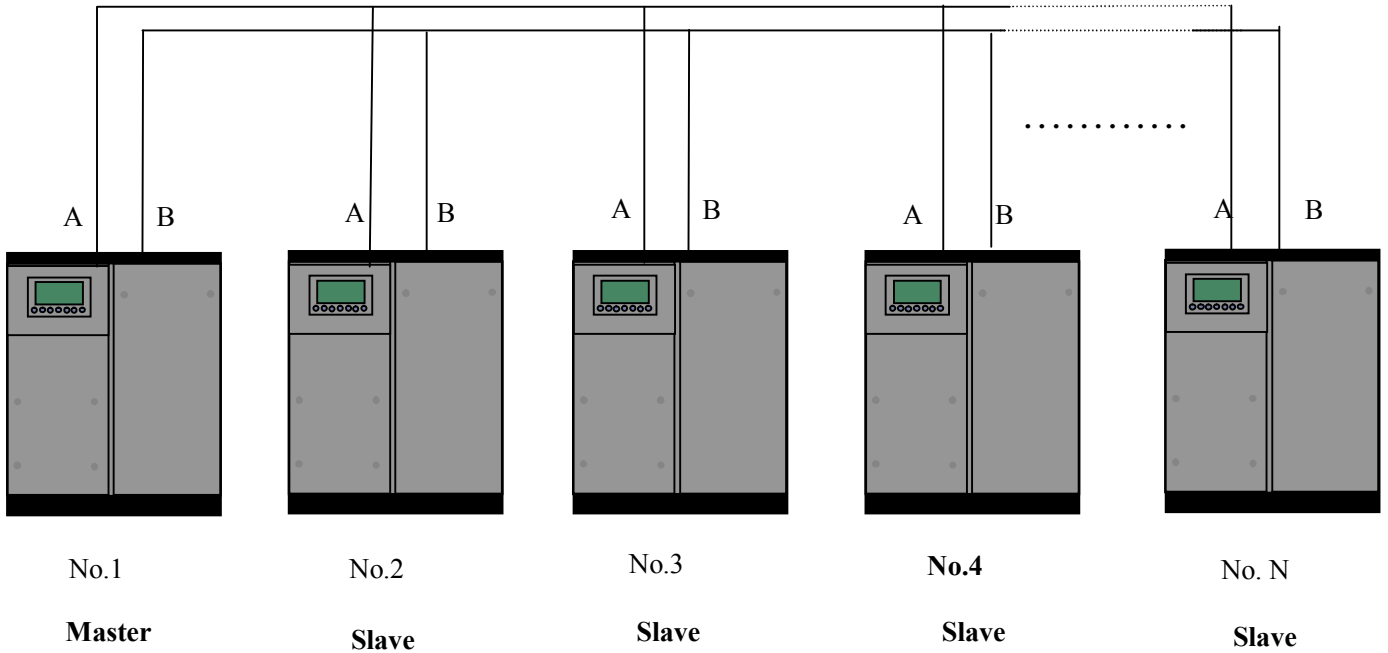



Picture9.1.1

Compressor with net communication address 0001 is master, others are slave. Any one MAM series compressor can be set as master or slave.

②、 Block mode setting

1. Set as master:

In main menu, press “” to enter select menu and choose USER PARAMETER, press “” and switch to the menu below:

LOAD P:
00.60MPa

Continually press “” until enter COM MODE menu

COM MODE:
BLOCK

Set COM MODE as BLOCK,COM ADD as “0001”. According to user requirement, set BLK STATE as MASTER, set ALTER TIME, BLK NUMER,BLK MIN,BLK MAX,BLK DELAY accordingly .After setting ,Power off and restart the controller to enable the setting.

2. Set as slave:



When MAM890 controller serves as slave ,it is only necessary to set COM MODE as BLOCK mode, set COM ADD from2-16 with sequence according to the quantity of compressors, .BLK STATE set as SLAVE.

③、 Start, stop block control:

Make sure block cables connect correctly and the parameter of compressors in net set correctly. Activate master, master controls the compressors in net automatically according to the air pressure detected . Block control stops at the same time when manually stop the master so master will no longer send command to compressor in net .

④、 Block communication receiving and sending message:

The message received and sent by RS485 can be displayed by the corresponding indication screen which is convenient for customer to make sure if they have received and feedback data in BLOCK mode or COM MODE.

The method to switch to communication menu is as below: press “” in main menu and enter main menu and select run parameter and move down the cursor to communication menu, press “” and switch to the COM MODE menu as below

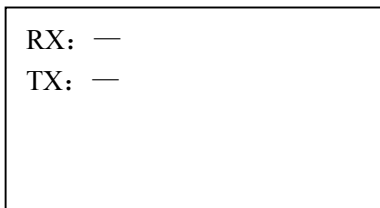

When controller receives data, RX “— ”and“*”display alternately, When sends data, TX:“— ”and“*”display alternately. When controller is in block control or communicates with monitoring center ,user can confirm the establishment of communication through this menu.

2、 Net Work

MAM860 controller supports MODBUS RTU protocol and can serve as slave when connect with other equipment and supports 03、 06、 16 MODBUS command. Communication baud rate: 9600BPS, 1 start bit, 8 data bits, 1 stop bits and even parity. For MODBUS register address, please see MODBUS communication manual.

9、Schematic Diagram

1, Star-delta start

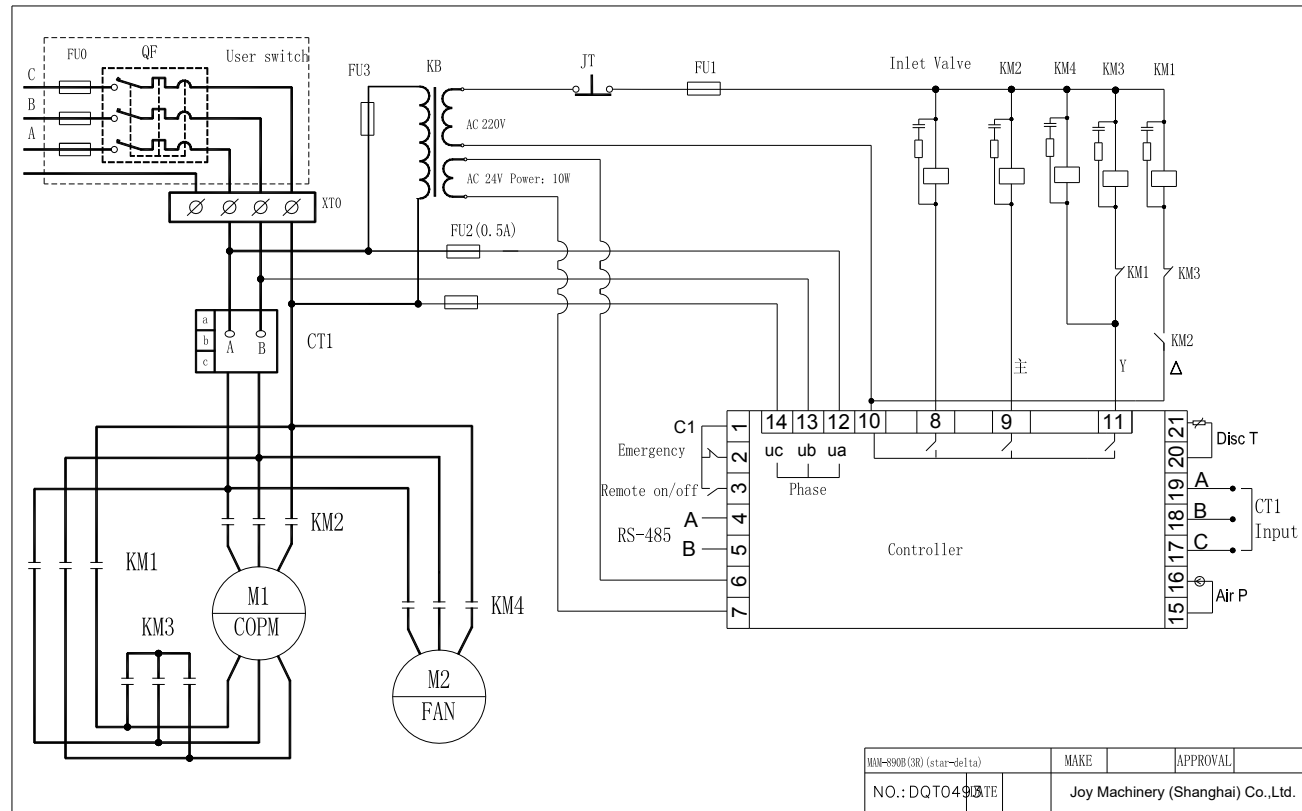

2,direct start

